

▼ Shown: EPHR-110



- Patented 'Safety Cage' jaw retention system
- High force hydraulic system for effortless pulling of large components
- Slim tapered jaws for better gripping in tight spots
- Available in 2 and 3 jaw design
- More efficient pulling, as one man can do the job where manual pullers often require two operators.

High-Tech Pulling



Transport and Store

Conveniently stores and transports hydraulic pullers and accessories. Order the **EPT-2550** Storage Cart and make your job easier to do!



Long Jaws

Used to increase the reach and spread of pullers. They maintain the same pulling capacity as the standard jaws, but reduce clamping force to 25%.

Page: 154



Application Tip

Because of the unique safety cage design, Posi Lock® pullers will grip on surfaces where normal pullers would slip off; e.g. tapered bearings.

▼ SELECTION CHART

Number of Jaws	Maximum Spread (mm)	Capacity ton (kN)	Model Number*
2	304	10 (101)	EPH-208
3	304		EPH-108
2	381	15 (142)	EPH-210
3	381		EPH-110
2	457	25 (232)	EPH-213
3	457		EPH-113
2	635	50 (498)	EPH-216
3	635		EPH-116

* Cylinder is not included.

Posi Lock® Hydraulic Grip Pullers

▼ SETS SELECTION CHART

Style	Capacity (ton)	Basic Puller	Cylinder	Stroke (mm)	Pump Set	Set Model Number *	 (kg)
2 Jaw Puller	10	EPH-208	RC-106	152	-	EPHR208	10
	10	EPH-208	RC-106	152	EP-1E	EPHS208E	27
	15	EPH-210	RC-1510	254	-	EPHR210	22
	15	EPH-210	RC-1510	254	EP-1E	EPHS210E	38
	25	EPH-213	RC-2514	362	-	EPHR213	44
	25	EPH-213	RC-2514	362	EP-1E	EPHS213E	53
	50	EPH-216	RC-5013	336	-	EPHR216	87
	50	EPH-216	RC-5013	336	EP-2E	EPHS216E	123
3 Jaw Puller	10	EPH-108	RC-106	152	-	EPHR108	11
	10	EPH-108	RC-106	152	EP-1E	EPHS108E	28
	15	EPH-110	RC-1510	254	-	EPHR110	23
	15	EPH-110	RC-1510	254	EP-1E	EPHS110E	39
	25	EPH-113	RC-2514	362	-	EPHR113	48
	25	EPH-113	RC-2514	362	EP-1E	EPHS113E	57
	50	EPH-116	RC-5013	336	-	EPHR116	91
	50	EPH-116	RC-5013	336	EP-2E	EPHS116E	127

* Standard set EPHS models shipped with 230 VAC pump.

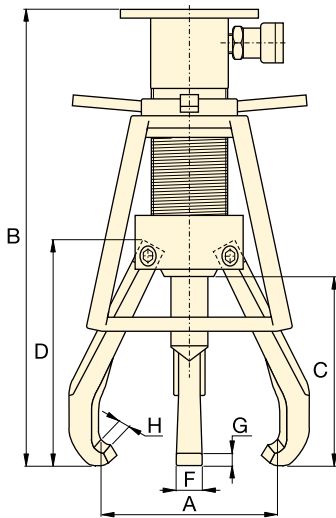

EPH Series



Capacity:

10 - 50 ton

Maximum Reach:

203 - 355 mm

Spread Range:

19 - 635 mm

Maximum Operating Pressure:

700 bar

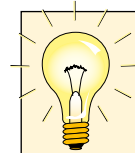





Pump Sets

All Posi Lock® Hydraulic Puller Sets that include 230 VAC pumps, will feature the following components:



	EP-1E Pump Set	EP-2E Pump Set
Pump	PUJ-1200E	ZE4210ME
Hose	HC-7210	HC-7210
Gauge	G-2535L	G-2535L
Adaptor	GA-3	GA-3

Components for 115 VAC pumps are available on request.

Dimensions (mm)							 (kg)	Model Number *	Accessories ¹⁾		
Spread min. - max.	Overall Length	Maximum Reach	Jaw Length	Jaw Width	Tip Clearance	Tip Depth			Standard included	Standard included	Optional
A	B	C	D	F	G	H					
19 - 304	498	203	237	22	7,4	6,9	6,4	EPH-208	EPH-155	EPH-11052	EP-11054
19 - 304	498	203	237	22	7,4	6,9	7,3	EPH-108	EPH-155	EPH-11052	EP-11054
25 - 381	665	245	270	25	11,2	9,1	10,0	EPH-210	EPH-155	EPH-11052	EPH-11054L
25 - 381	665	245	270	25	11,2	9,1	11,3	EPH-110	EPH-155	EPH-11052	EPH-11054L
63 - 457	846	304	348	31	12,9	9,7	21,3	EPH-213	EPH-257	EPH-11352	EPH-11354L
63 - 457	846	304	348	31	12,9	9,7	25,0	EPH-113	EPH-257	EPH-11352	EPH-11354L
76 - 635	919	355	413	36	15,0	11,7	40,8	EPH-216	EPH-508	EPH-11652	EPH-21654L
76 - 635	919	355	413	36	15,0	11,7	45,4	EPH-116	EPH-508	EPH-11652	EPH-11654L

¹⁾ See next page for details.

▼ RAM POINT SETS SELECTION CHART

Fits Puller Set Model Number	EPH-208, EPH-210 EPH-108, EPH-110	EPH-213 EPH-113	EPH-216 EPH-116
			
Ram Point Set ¹⁾ Model Number	EPH-155	EPH-257	EPH-508
Ram Points Included:	Ram Point Dimensions Diameter x Length (mm)		
Flat Ram Points	ø25 x 25	ø38 x 57	ø51 x 76
	ø25 x 76	ø51 x 57	ø70 x 76
Tapered Ram Points	–	ø51 x 102	ø70 x 127
	ø25 x 38	ø38 x 64	ø51 x 95
	ø25 x 89	ø51 x 64	ø51 x 95
Ram Point Adaptor	–	–	ø70 x 57

¹⁾ Standard included in EPH-Series Posi Lock Pullers.

EPH Series



Capacity:
10 - 50 ton

Maximum Reach:
38 - 762 mm

Spread Range:
246 - 508 mm





IMPORTANT!
Always wear Safety Goggles while using pullers.

▼ LIFT PLATE SELECTION CHART

Fits Puller Set Model Number	Model Number *	Thick-ness (mm)	Dia-meter (mm)	
EPH-208	EPH-11052	6,4	ø153	
EPH-108	EPH-11052	6,4	ø153	
EPH-210	EPH-11052	6,4	ø153	
EPH-110	EPH-11052	6,4	ø153	
EPH-213	EPH-11352	9,7	ø203	
EPH-113	EPH-11352	9,7	ø203	
EPH-216	EPH-11652	9,7	ø254	
EPH-116	EPH-11652	9,7	ø254	

* Mounting screws included. Lifting plates are standard included with EPH-Series Pullers.

▼ LONG JAW SELECTION CHART

Fits Puller Set Model Number	Model Number	Number of Jaws required	Spread (mm)	Reach (mm)	 (kg)		Long Jaws are optional accessories and used for added reach and spread. They have the same load capacity as standard jaws with 25% of the clamping force.
EPH-208	EP-11054	2	57 - 381	246	1,1		
EPH-108	EP-11054	3	57 - 381	246	1,1		
EPH-210	EPH-11054L	2	38 - 559	401	2,5		
EPH-110	EPH-11054L	3	38 - 559	401	2,5		
EPH-213	EPH-11354L	2	38 - 762	508	4,8		
EPH-113	EPH-11354L	3	38 - 762	508	4,8		
EPH-216	EPH-21654L	2	50 - 965	635	7,5		
EPH-116	EPH-11654L	3	50 - 965	635	7,5		